

DREMPELHULP KITS 2019

ALGEMENE INFORMATIE

De KIT's zijn eenvoudig te monteren
en eenvoudig in hoogte aan te passen



KIT 1

KIT 2

KIT 3

KIT 4

KIT 5

HOOGTE:

BREEDTE: 75 cm

LENGTE: 100 cm

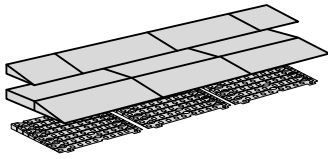

1,8 - 5,5 cm

KIT 001

KIT 101

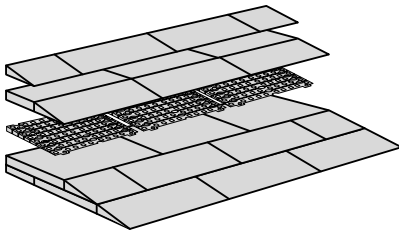

3,6 - 9,1 cm

KIT 002

KIT 102

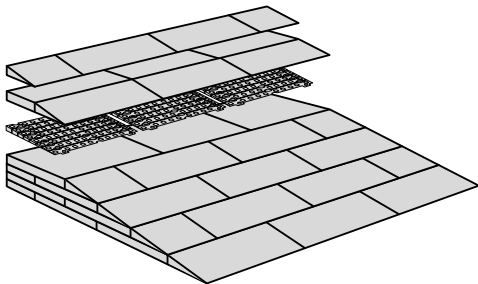

7,2 - 12,7 cm

KIT 003

KIT 103

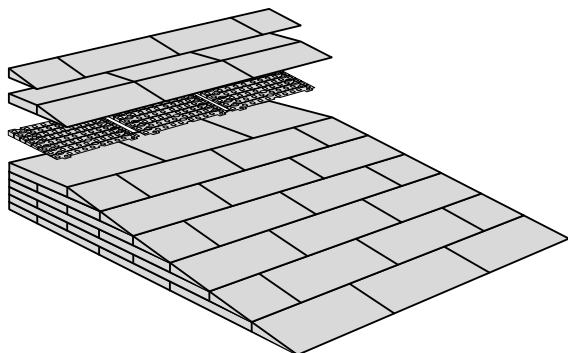

10,8 - 16,3 cm

KIT 004

KIT 104

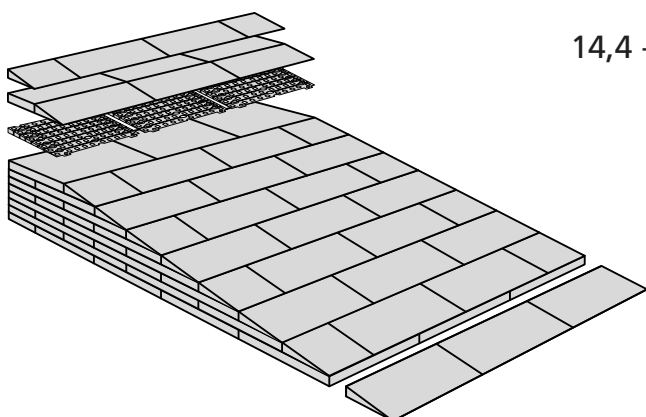

14,4 - 19,9 cm

KIT 005

KIT 105

6D7? B7>: G>BB>3F8AD?

>7@9F7: 75cm
4D776F7: 75 cm

LENGTE: 100 cm
BREEDTE: 75 cm

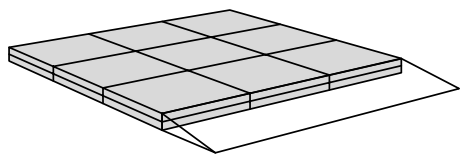

KIT 001 Platform

KIT 101 Platform

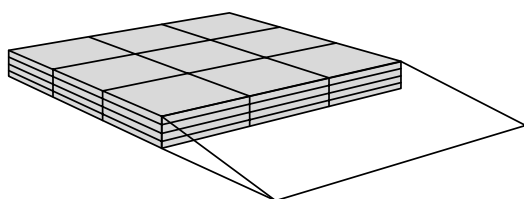

KIT 002 Platform

KIT 102 Platform

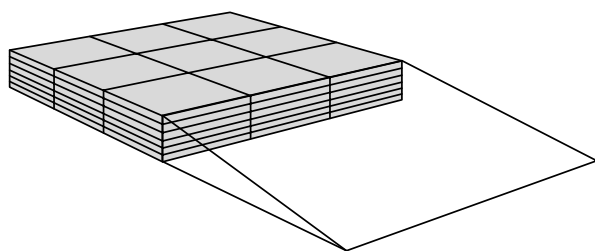

KIT 003 Platform

KIT 103 Platform

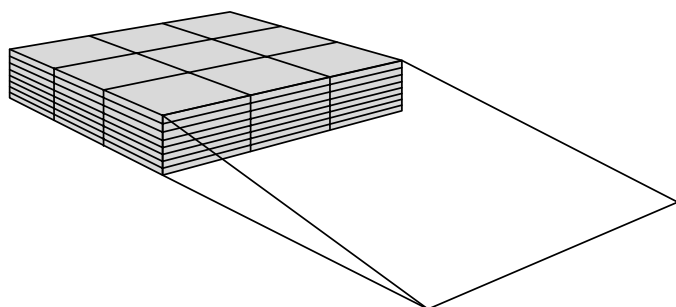

KIT 004 Platform

KIT 104 Platform

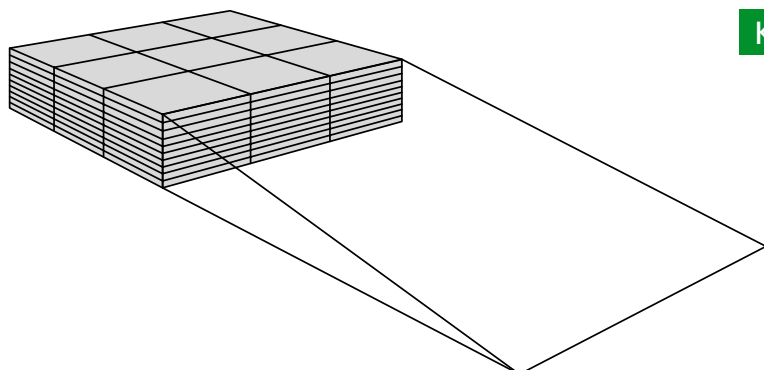

KIT 005 Platform

KIT 105 Platform

DREMPELHULP HOEKEN

De hoeken passen zowel links als rechts van de KIT's:

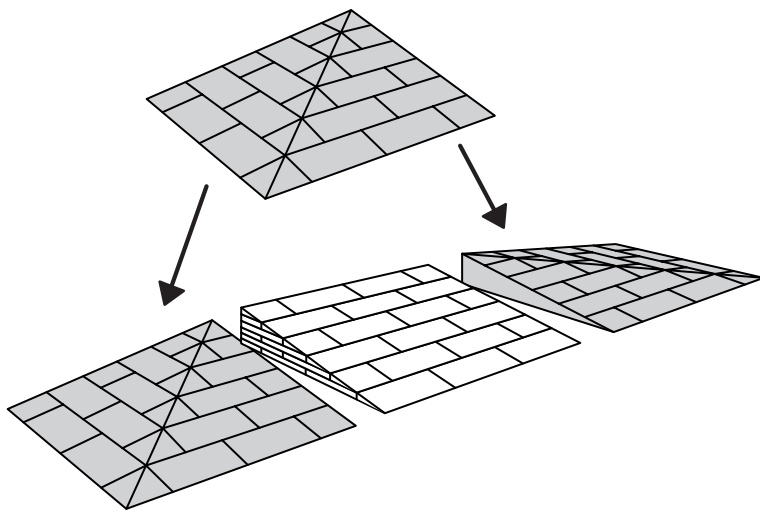

KIT 001 HOEK

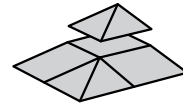

KIT 002 HOEK

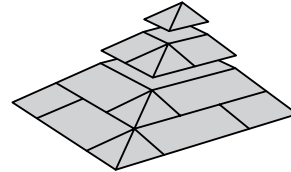

KIT 003 HOEK

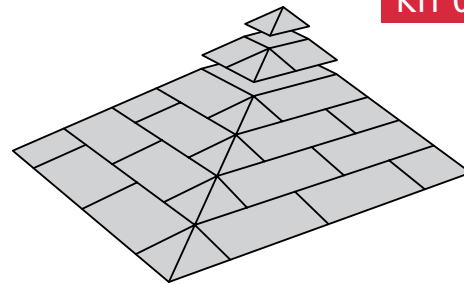

KIT 004 HOEK

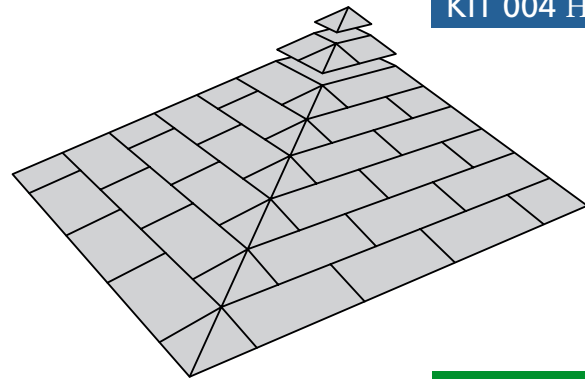

KIT 005 HOEK

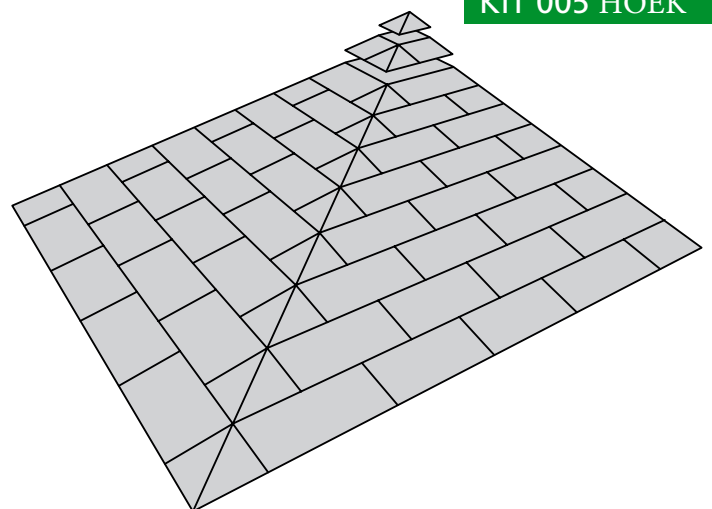

INSPIRATIE

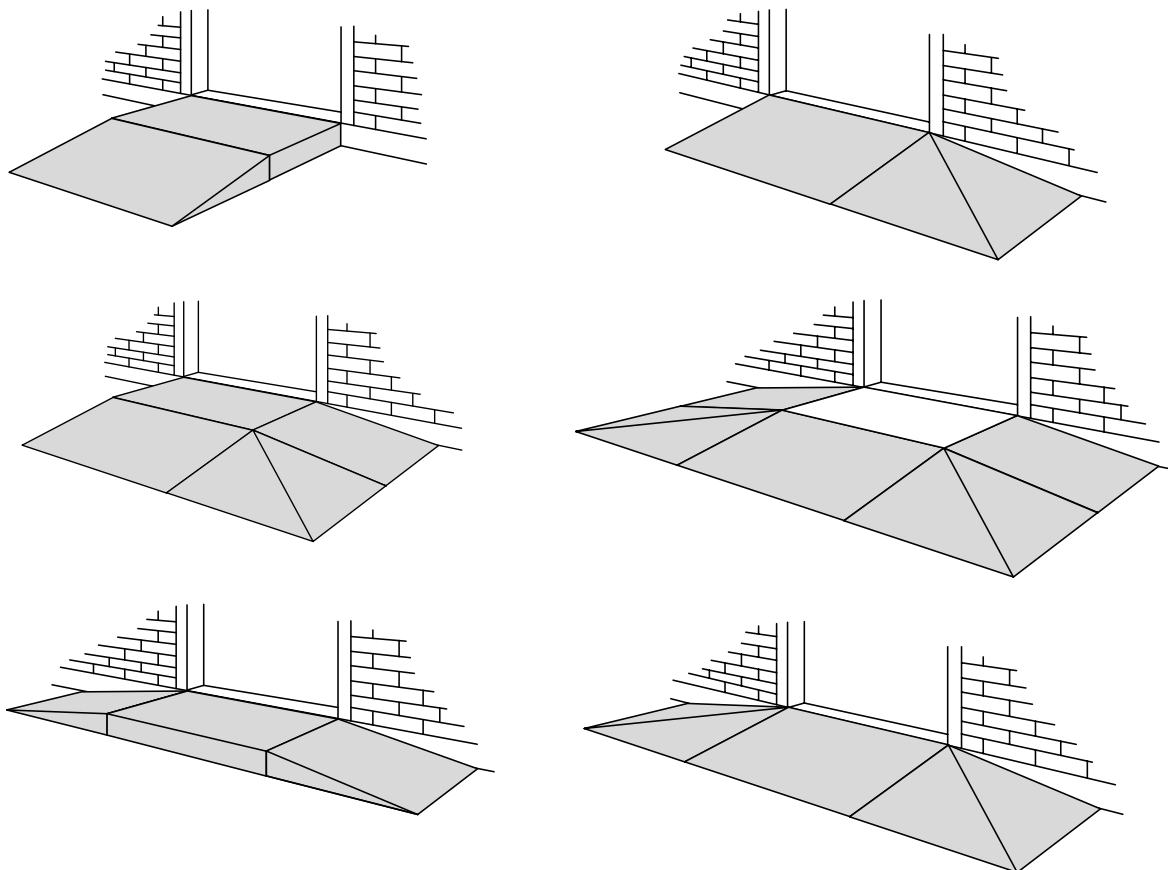

OPPERVLAKKEN

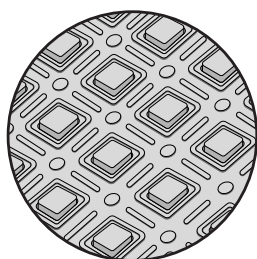

Oppervlakte	Gebruik	Beschikbare producten
MET SLIPSTOP	BUITENSHUIS	KIT PLATFORM HOEK

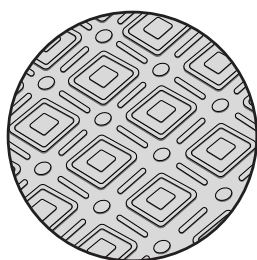

Oppervlakte	Gebruik	Beschikbare producten
ZONDER GATEN	BINNENSHUIS	KIT PLATFORM

RAMP INSTELLING

Met de Ramp Adjuster is het mogelijk om hellingen fijn af te stellen.
Aanpassingen met slechts 2 mm hoogteverschillen:

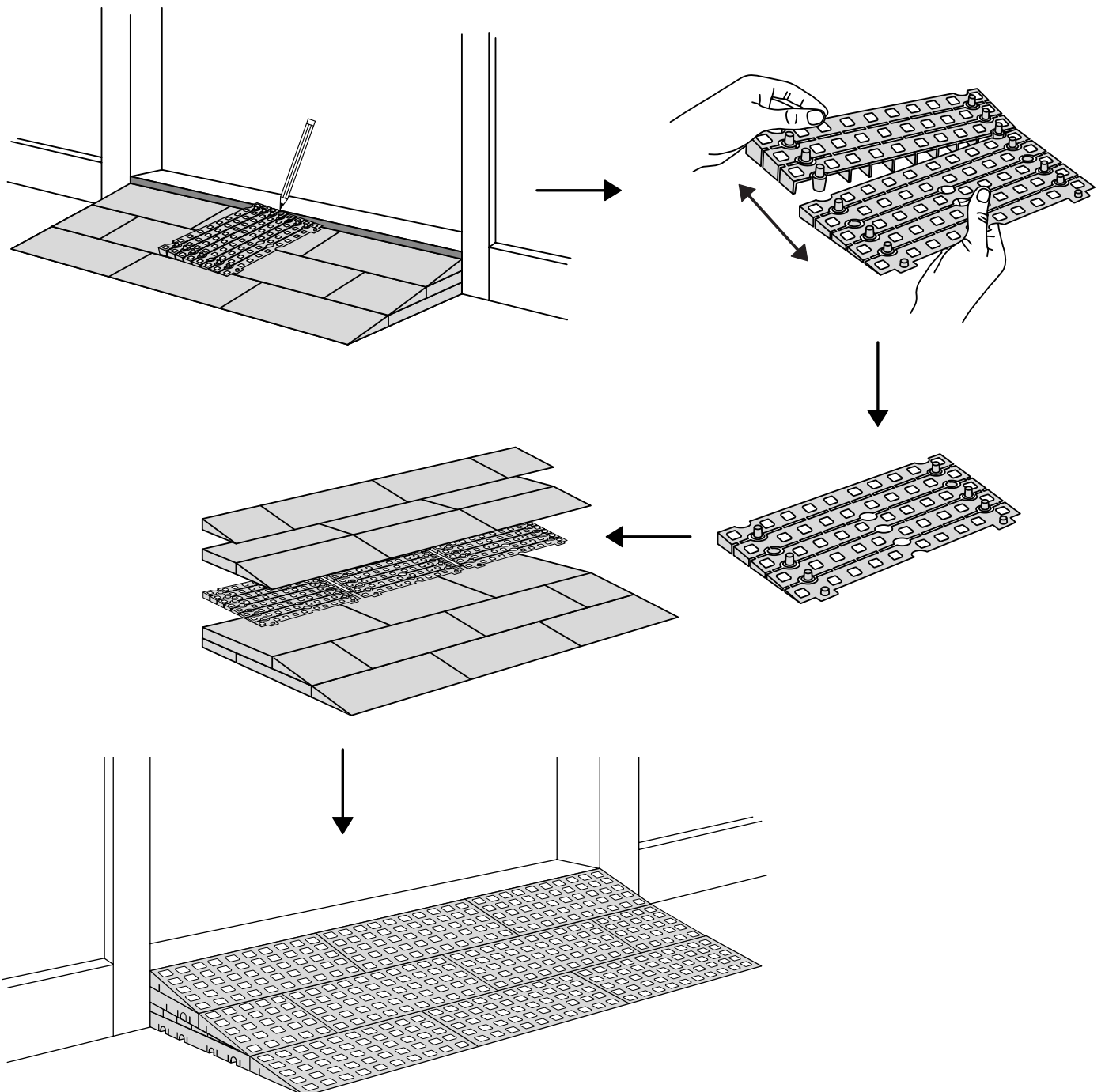
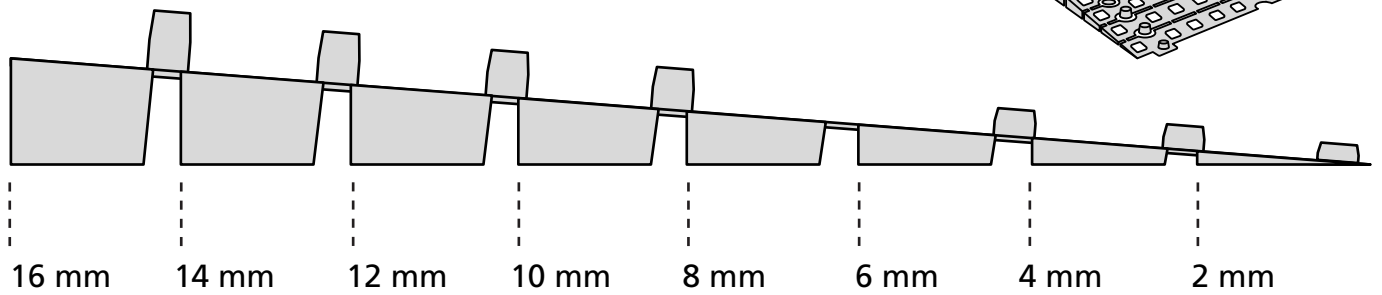
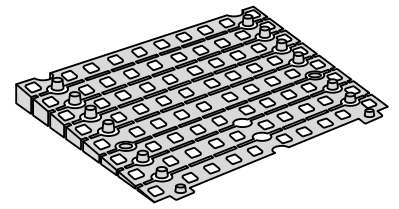

DEEL PAKKETTEN

KIT PAKKET 1



1 DREMPEL VERSTELPLAAT

KIT PAKKET 2

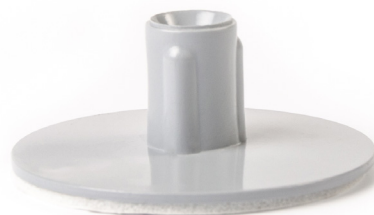

1 BEVESTIGINGSVOET MET SCHROEF

KIT PAKKET 3



ZAK VAN 10 R-LOCKS

KIT PAKKET 4



ZAK VAN 10 T-LOCKS

KIT PAKKET 5



ZAK VAN 10 STUKS S-LOCK

KIT PAKKET 6



ZAK VAN 10 STUKS C-LOCK

KIT Sparepart 7



ZAK VAN 10 RUBBEREN VOETEN

KIT Sparepart 8



ZAK VAN 3 UITBEIDINGSPLUGGEN



**SILEMA
REVALIDATIE
TECHNIEK**

www.silema.nl

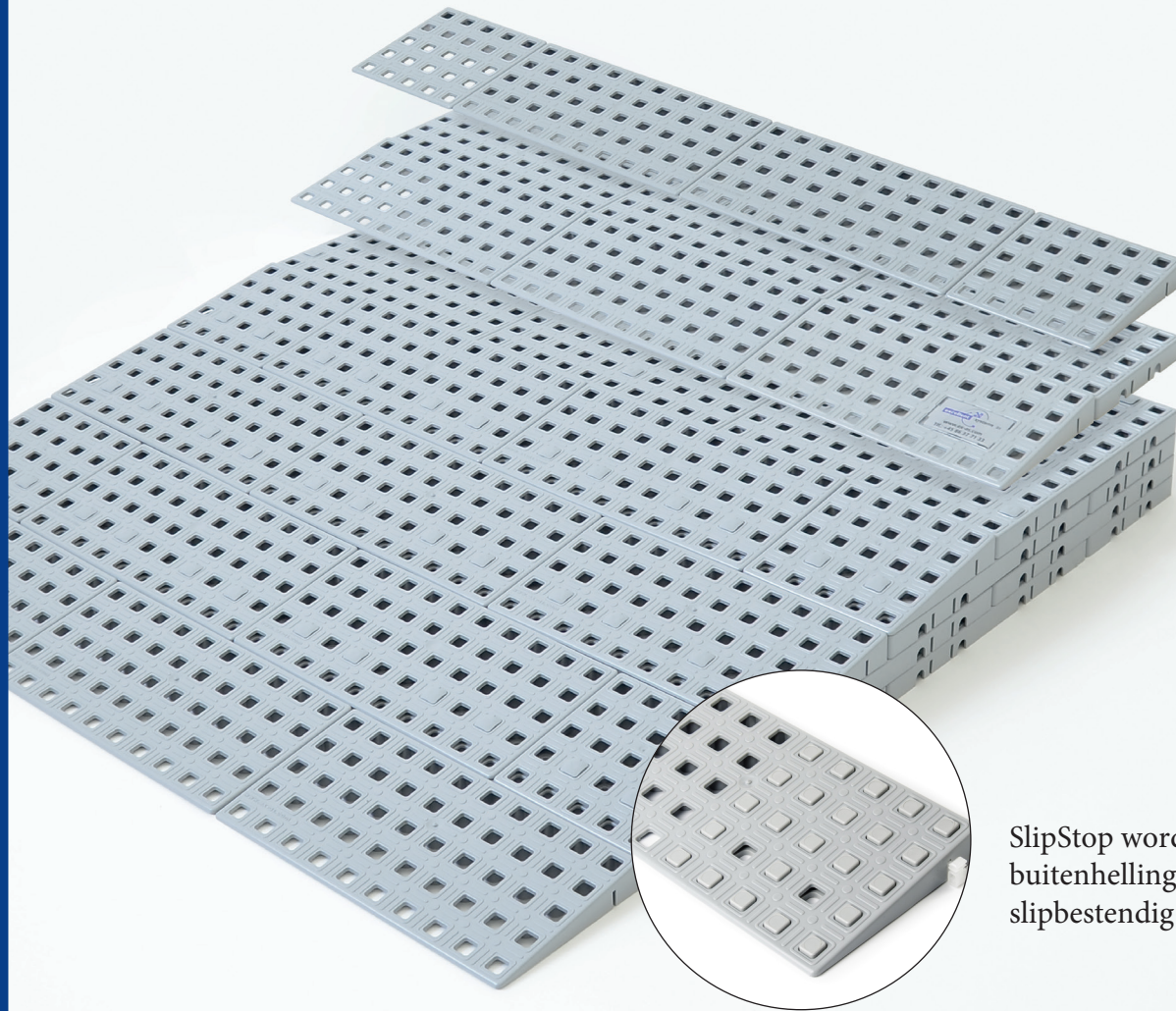

SlipStop wordt gebruikt voor buitenhellingen om een extreem slipbestendig oppervlak te creëren.



WWW.SILEMA.NL



verkoop@silema.nl



Rondven 40, 6026 PX Maarheeze



0495 - 599107

CE Danish Design Pat. Pend. and produced
in Denmark by Excellent Systems A/S